

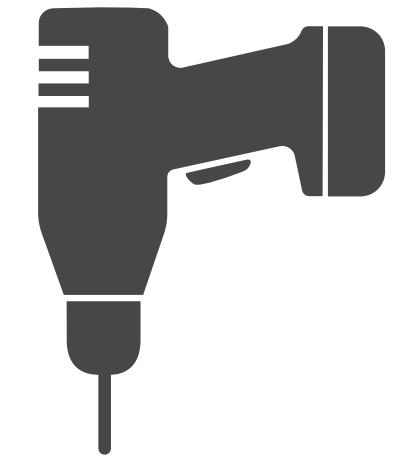

1



4x Ø10 mm

Min C25



2

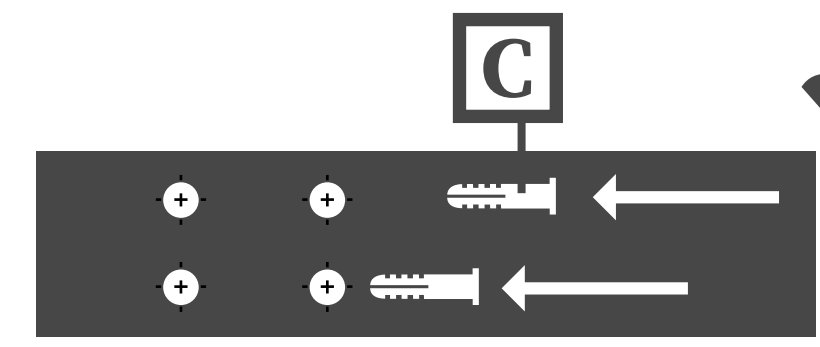

3

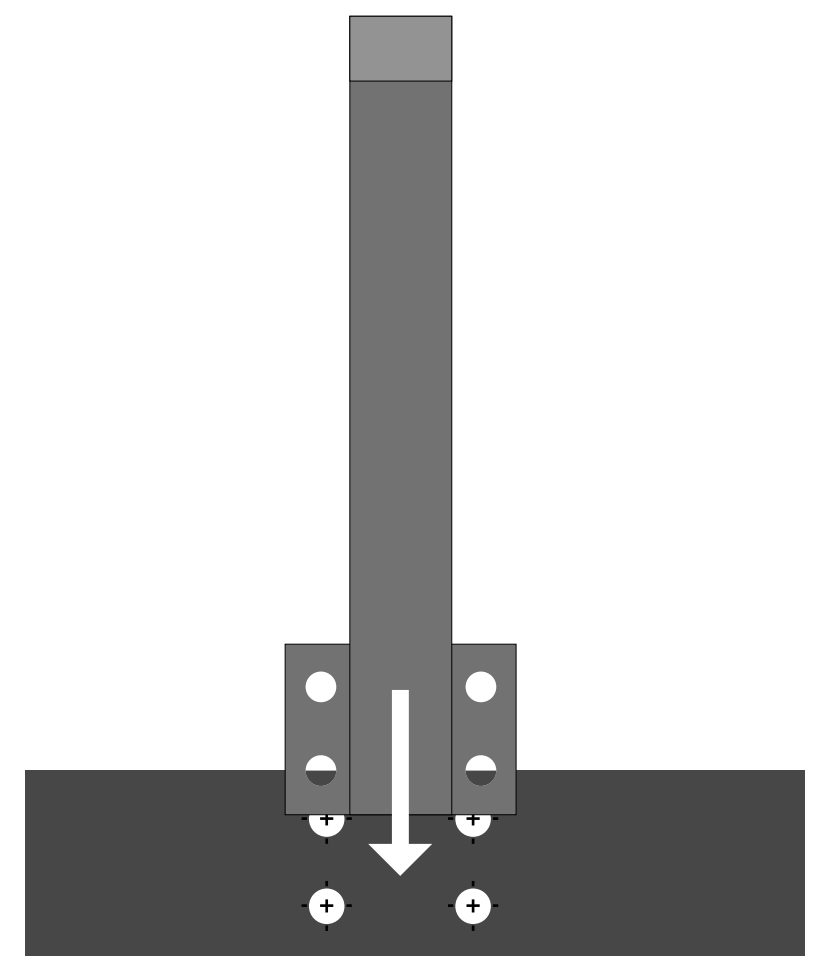

4

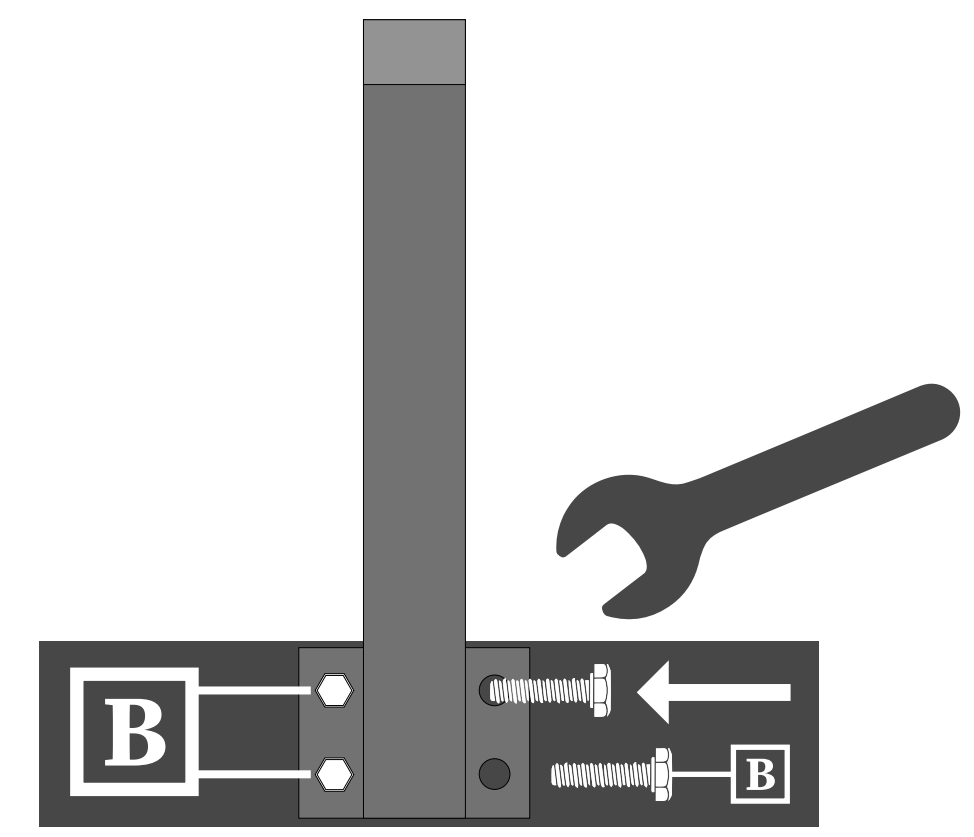

5

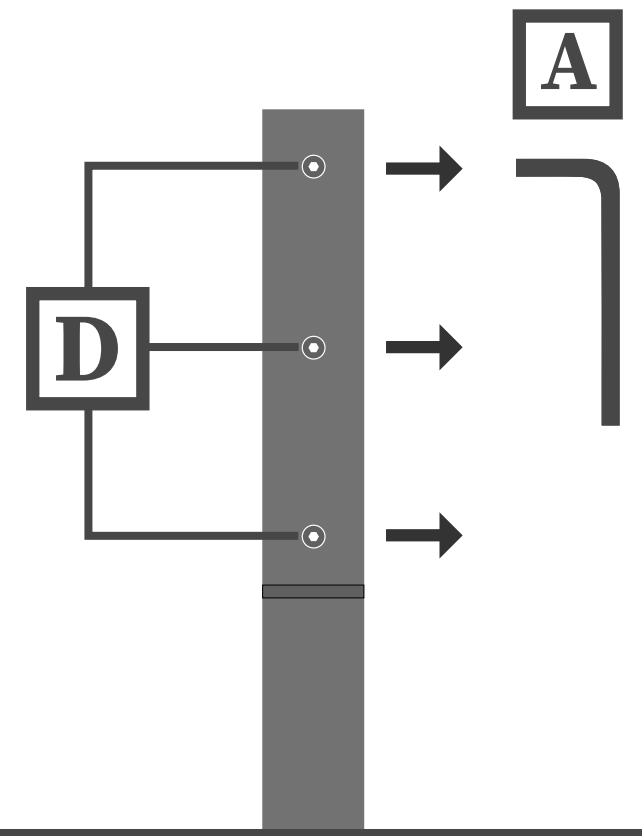

6

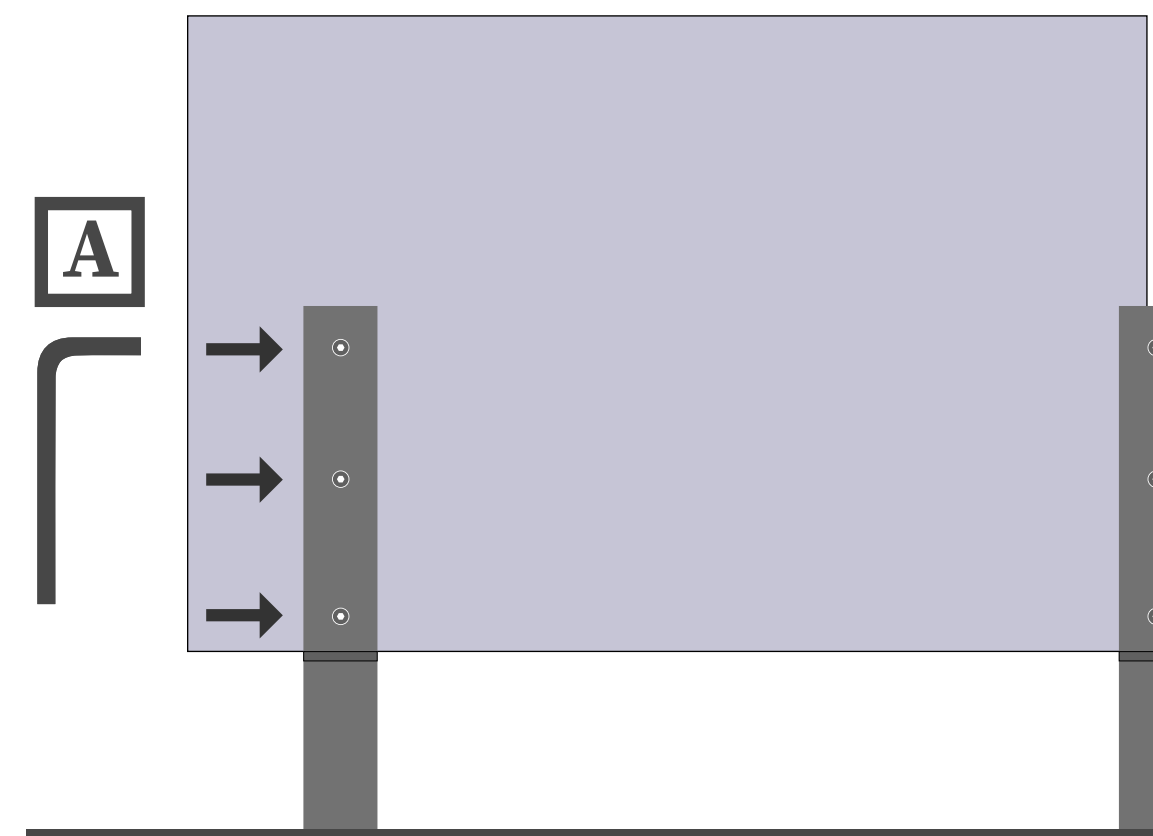

7

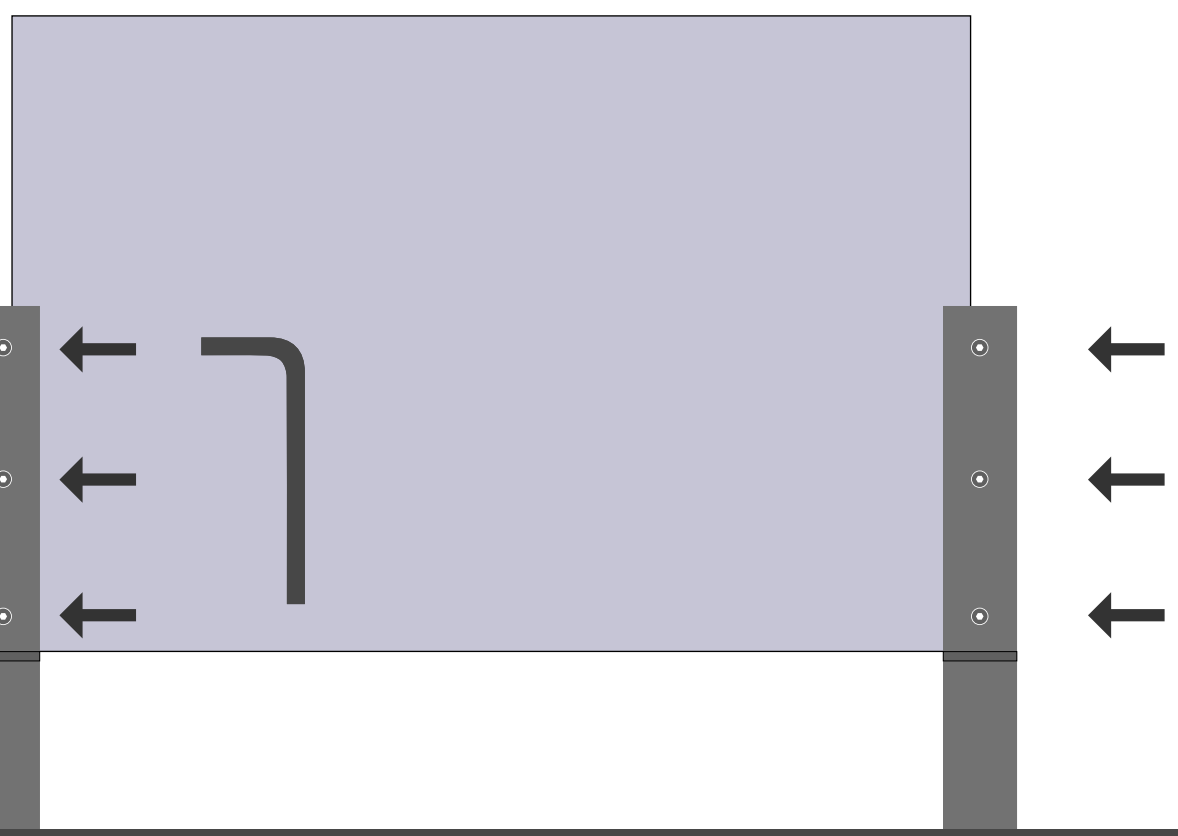

END

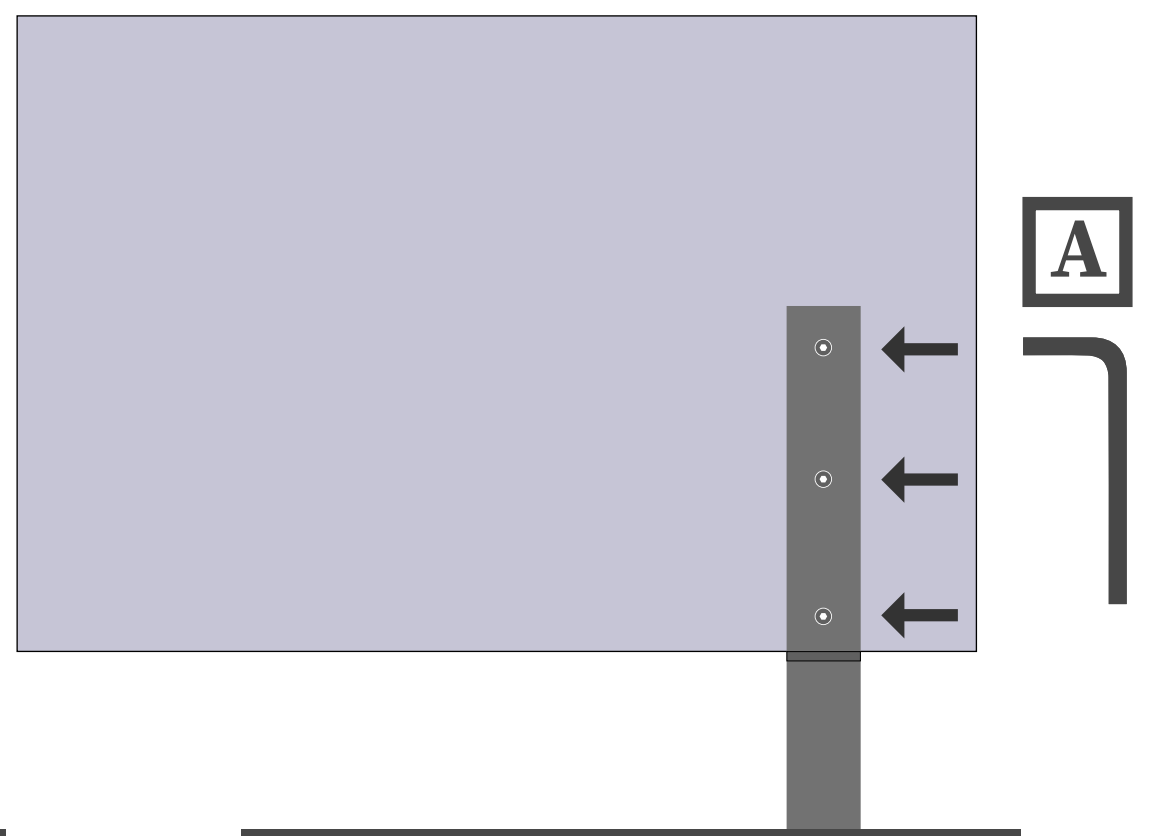



*A csomag csak a D csavarokat tartalmazza

A  $\updownarrow 3 \text{ mm}$

B  $(\updownarrow 10 \text{ mm} \leftrightarrow 100 \text{ mm}) \times 4 \text{ pc}$

C  $(\updownarrow 10 \text{ mm} \leftrightarrow 100 \text{ mm}) \times 4 \text{ pc}$

D  $(\updownarrow 0,5 \text{ mm} \leftrightarrow 35 \text{ mm}) \times 3 \text{ pc}$

